



# Instruction Manual

High Traffic Sliding Gate Operator

**RAM 5000**  
**RAM 5100**  
**RAM 5200**

Opening the way...



FOR CLASS I, II, III, IV VEHICULAR GATE OPERATORS





# TABLE OF CONTENTS

- Important Safety Requirements & Instructions ..... 1
- Responsibilities of Installers and Technicians ..... 2
- Important Safety Requirements by UL Standards ..... 3
- Classes of Vehicular Gate Operators ..... 4
- General Specifications & Emergency Chain Release ..... 5
- Installation Specifications ..... 6
- Types of Installations ..... 7
- Loop Sensor Installation & Gate Travel Adjustment ..... 8
- Pushbutton Controls & Master/Slave Installation ..... 9
- Dip Switch Configuration ..... 10-11
- Terminal Strip Connections ..... 12-13
- Ramset "Intelligate" Control Board ..... 14
- Wire Board Connections ..... 15
- Parts Diagram ..... 16
- Bill of Materials ..... 17-18
- Gate Entrance Safety Precautions ..... 19
- Important Information for the Homeowner ..... 20
- Troubleshooting Table ..... 21

RAM 5000 • 5100 • 5200

 **WARNING** Do not install this gate operator if you do not have experience or appropriate training with gate operators.

 **IMPORTANT SAFETY REQUIREMENTS & INSTRUCTIONS**

**WARNING** To reduce the risk of injury or death:

<ol style="list-style-type: none"> <li>1. READ AND FOLLOW ALL INSTRUCTIONS.</li> <li>2. Never let children operate or play with gate controls. Keep the remote control away from children.</li> <li>3. Always keep people and objects away from the gate. NO ONE SHOULD CROSS THE PATH OF THE MOVING GATE.</li> <li>4. Test the Vehicular Gate Operator monthly. The gate MUST reverse on contact with a rigid object or stop when an object activates the non-contact sensors. After adjusting the limit of travel, retest the Vehicular Gate Operator. Failure to adjust and retest the</li> </ol>	<p>Vehicular Gate Operator properly can increase the risk of injury or death.</p> <ol style="list-style-type: none"> <li>5. Use the Emergency Release only when power switch or circuit breaker has been turned off. Using the Emergency Release during a power failure can be a hazard if power is abruptly restored.</li> <li>6. KEEP GATES PROPERLY MAINTAINED. Read the Owner's Manual. Have a qualified service person make repairs to gate hardware.</li> <li>7. The entrance is for vehicles only. Pedestrians must use separate entrance.</li> <li>8. SAVE THESE INSTRUCTIONS.</li> </ol>
--	---

## RESPONSIBILITIES OF INSTALLERS AND TECHNICIANS

### INSTALLATION

---

- READ AND UNDERSTAND THE INSTRUCTION MANUAL BEFORE ATTEMPTING ANY INSTALLATION.
- DO NOT EXCEED THE EQUIPMENT SPECIFICATIONS.
- INSURE A SAFE AND PROPER INSTALLATION.
- INSTALL THIS EQUIPMENT IN ACCORDANCE WITH THE UL 325 SPECIFICATIONS.
- MAKE SURE TO ELIMINATE ANY PINCH POINTS EXISTING ON THE INSTALLATION. (ie. ROLLERS, ARMS...etc.)
- RAMSET GATE OPERATORS MUST BE INSTALLED BY A TRAINED TECHNICIAN.

### SAFETY DEVICES

---

- REMOVE OR PROTECT ALL PINCH POINTS FROM THE GATE OPERATOR.
- MAKE SURE EVERY INSTALLATION HAS A MINIMUM OF ONE NON-CONTACT SAFETY DEVICE (SUCH AS A PHOTO EYE OR LOOP DETECTOR).
- CHECK THE E.R.D. SENSITIVITY FOR PROPER ADJUSTMENTS.
- MAKE SURE THAT ALL AREAS AROUND THE GATE ARE SAFE AND SECURE. (SUCH AS THE FRONT, REAR, AND TRAVEL AREA).

### COMMUNICATE WITH THE END-USER

---

- INSTRUCT THE END USER ON HOW TO SAFELY OPERATE ALL FUNCTIONS OF THE OPERATOR.
- INSTRUCT THE END-USER ON HOW TO SAFELY USE THE EMERGENCY RELEASE.
- CLEARLY LABEL AND IDENTIFY THE CIRCUIT BREAKER FOR THE OPERATOR.
- SHOW THE END-USER THE LOCATION OF THE CIRCUIT BREAKER FOR THE OPERATOR.
- THOROUGHLY EXPLAIN ANY AND ALL WARRANTIES ASSOCIATED WITH THE OPERATOR AND INSTALLATION.
- KEEP A COPY OF EACH MANUAL HANDY FOR FUTURE REFERENCES.
- PROVIDE THE END-USER WITH THE “HOME OWNERS MANUAL PACKET” (INCLUDED WITH EVERY OPERATOR).

## IMPORTANT SAFETY REQUIREMENTS BY UL STANDARDS

**Prior to installation, the following must be observed: (per UL 325.56.8.4).**

**a)** Install the gate operator only when:

1. The operator is appropriate for the construction of the gate and the usage Class of the gate,
2. All openings of a horizontal slide gate are guarded or screened from the bottom of the gate to a minimum of 4 feet (1.22 m) above the ground to prevent a 2 1/4 inch (57.2 mm) diameter sphere from passing through the openings anywhere in the gate, and in that portion of the adjacent fence that the gate covers in the open position.
3. All exposed pinch points are eliminated or guarded, and
4. Guarding is supplied for exposed rollers.

**b)** The operator is intended for installation only on gates used for vehicles. Pedestrians must be supplied with a separate access opening. The pedestrian access opening shall be designed to promote pedestrian usage. Locate the gate such that persons will not come in contact with the vehicular gate during the entire path of travel of the vehicular gate.

**c)** The gate must be installed in a location so that enough clearance is supplied between the gate and adjacent structures when opening and closing to reduce the risk of entrapment. Swinging gates shall not open into public access areas.

**d)** The gate must be properly installed and work freely in both directions prior to the installation of the gate operator. Do not over-tighten the operator clutch or pressure relief valve to compensate for a damaged gate.

**e)** For gate operators utilizing Type D protection:

1. The gate operator controls must be placed so that the user has full view of the gate area when the gate is moving.
2. The placard as required by 58.1.6 shall be placed adjacent to the controls,
3. An automatic closing device (such as a timer, loop sensor, or similar device) shall not be employed, and
4. No other activation device shall be connected.

**f)** Controls intended for user activation must be located at least six feet (6') away from any moving part of the gate and where the user is prevented from reaching over, under, around or through the gate to operate the controls. Outdoor or easily accessible controls shall have a security feature to prevent unauthorized use.

**g)** The stop and/or reset button must be located in the line-of-sight of the gate. Activation of the reset control shall not cause the operator to start.

**h)** A minimum of two (2) WARNING SIGNS shall be installed, one on each side of the gate where easily visible.

**i)** For gate operators utilizing a non-contact sensor in accordance with UL 31.1.1:

1. See instructions on the placement of non-contact sensors for each Type of application.
2. Care shall be exercised to reduce the risk of nuisance tripping, such as when a vehicle, trips the sensor while the gate is still moving, and
3. One or more non-contact sensors shall be located where the risk of entrapment or obstruction exists, such as the perimeter reachable by a moving gate or barrier.

**j)** For a gate operator utilizing a contact sensor in accordance with 31.1.1:

1. One or more contact sensors shall be located where the risk of entrapment or obstruction exists, such as at the leading edge, trailing edge, and postmounted both inside and outside of a vehicular horizontal slide gate.
2. One or more contact sensors shall be located at the bottom edge of a vehicular vertical lift gate.
3. One or more contact sensors shall be located at the pinch point of a vehicular vertical pivot gate.
4. A hardwired contact sensor shall be located and its wiring arranged so that the communication between the sensor and the gate operator is not subjected to mechanical damage.
5. A wireless contact sensor such as one that transmits radio frequency (RF) signals to the gate operator for entrapment protection functions shall be located where the transmission of the signals are not obstructed or impeded by building structures, natural landscaping or similar obstruction. A wireless contact sensor shall function under the intended end-use conditions.
6. One or more contact sensors shall be located on the inside and outside leading edge of a swing gate. Additionally, if the bottom edge of a swing gate is greater than 6 inches (152 mm) above the ground at any point in its arc of travel, one or more contact sensors shall be located on the bottom edge.
7. One or more contact sensors shall be located at the bottom edge of a vertical barrier (arm).

## CLASSES OF VEHICULAR GATE OPERATORS

**Vehicular horizontal slide-gate operator (or system)** - A vehicular gate operator (or system) that controls a gate which slides in a horizontal direction that is intended for use for vehicular entrance or exit to a drive, parking lot, or the like.

**Vehicular swing-gate operator (or system)** - A vehicular gate operator (or system) that controls a gate which swings in an arc in a horizontal plane that is intended for use for vehicular entrance or exit to a drive, parking lot or the like.

**Residential vehicular gate operator-Class I** - A vehicular gate operator (or system) intended for use at a home of one-to four single family dwellings, or a garage or parking area associated there with.

**Commercial/general access vehicular gate operator-Class II** - A vehicular gate operator (or system) intended for use in a commercial location or building such as a multi-family housing unit (five or more single family units), hotels, garages, retail stores, or other buildings serving the general public.

**Industrial/limited access vehicular gate operator-Class III** - A vehicular gate operator (or system) intended for use in an industrial location or building such as a factory or loading dock area or other locations not intended to service the general public.

**Restricted access vehicular gate operator-Class IV** - A vehicular gate operator (or system) intended for use in a guarded industrial location or building such as an airport security area or other restricted access locations not servicing the general public, in which unauthorized access is prevented via supervision by security personnel.

## RECOMMENDED ELECTRICAL CONNECTION

A 3 wire, 120 VAC or 220 VAC electrical circuit with a 15 amps independent circuit breaker for single operator and a 20 amps for Master/Slave. Ideally, the electrical conduits should exit the concrete under the operator. Low voltage control wires must be run in a separate conduit to the operator.

**NOTE:** Always consult and follow all local building and electrical codes prior to installation.

## RECOMMENDED WIRE GAUGE

		AMPERES	
INPUT POWER	MOTOR HP	RUN	START
120V Single Phase	1/2	4.7	5.0
120V Single Phase	3/4	8.0	8.7
220 VAC Single Phase	1	4.7	5.0

MAXIMUM CONDUIT DISTANCE IN FEET USING COPPER WIRE BY WIRE SIZE			
14ga.	12ga.	10ga.	8ga.
Up to 100'	100-350'	350-650'	800'
Up to 50'	50-150'	150-250'	450'
Up to 100'	100-350'	350-650'	800'



## GENERAL SPECIFICATIONS

*The following specifications are based on a standard front level installation. Contact a local technician to determine which operator is best suited for your installation.*

Model	RAM 5000	RAM 5100	RAM 5200
<b>Max. Gate Length</b>	40 Feet	40 Feet	40 Feet
<b>Max. Gate Weight</b>	1000 lbs	2000 lbs	3000 lbs
<b>Cycles</b>	Continuous	Continuous	Continuous
<b>Capacitor</b>	Aerovox 65 $\mu$ f, 240 V, 50/60 HZ, protected S 1000AFC	Aerovox 65 $\mu$ f, 240 V, 50/60 HZ, protected S 1000AFC	Aerovox 65 $\mu$ f, 240 V, 50/60 HZ, protected S 1000AFC
<b>Application</b>	Commercial/ Industrial	Commercial/ Industrial	Commercial/ Industrial
<b>Finish and Construction</b>	Gold/Zinc Plated 1/4" H.R. Metal	Gold/Zinc Plated 1/4" H.R. Metal	Gold/Zinc Plated 1/4" H.R. Metal
<b>Continuous Duty Motor</b>	1/2 Hp 120 VAC 4.5 amp 1625 rpm. 50/60 Hz.	3/4 Hp 120 VAC 8.5 amp 1625 rpm. 50/60 Hz.	1 Hp 220 VAC 4.5 amp 1625 rpm. 50/60 Hz.
<b>Operating Temperature</b>	-10°F to 160°F	-10°F to 160°F	-10°F to 160°F
<b>Gate Travel Speed</b>	Approx. 1' per sec	Approx. 1' per sec	Approx. 1' per sec
<b>Power Failure Release</b>	Chain release or option battery back-up system (less than 1000 lbs)	Chain release or option battery back-up system (less than 1000 lbs)	Chain release or option battery back-up system (less than 1000 lbs)
<b>Chassis Base Dimensions</b>	W 13½" x L 14¼"	W 13½" x L 14¼"	W 13½" x L 14¼"
<b>Overall Dimensions</b>	H25" x L16½" x W 18½"	H25" x L16½" x W 18½"	H25" x L16½" x W 18½"
<b>Shipping Weight</b>	125 lbs	125 lbs	125 lbs

RAM 5000 • 5100 • 5200

**⚠ WARNING** Do not exceed the specifications. The warranty on your unit will be void if the installation exceeds the recommended specifications.

## EMERGENCY CHAIN RELEASE



Remove the lock from the chain release and open the gate manually

# INSTALLATION SPECIFICATIONS



## WARNING

Do not exceed the specifications. The warranty on your unit will be void if the installation exceeds the recommended specifications.

All Sliding Gate Operators are factory preset for (LH) Left Hand Installations.

### CONCRETE PAD CONSTRUCTION

Dimensions given for the pad are based on soil bearing shear of 2000 P.S.F. These figures may have to be adjusted depending on local soil conditions.

1. Construct form for mounting pad according to dimensions shown in Figure 1, 2 and 3.
2. Locate mounting pad according to dimensions given in illustration.
3. Level top edge of form.
4. Set reinforcing bars and wire mesh.
5. Mix concrete, pour mixture into form. Level and finish surface after pouring is complete.
6. Allow pad to cure for 48 hours, and remove forms.

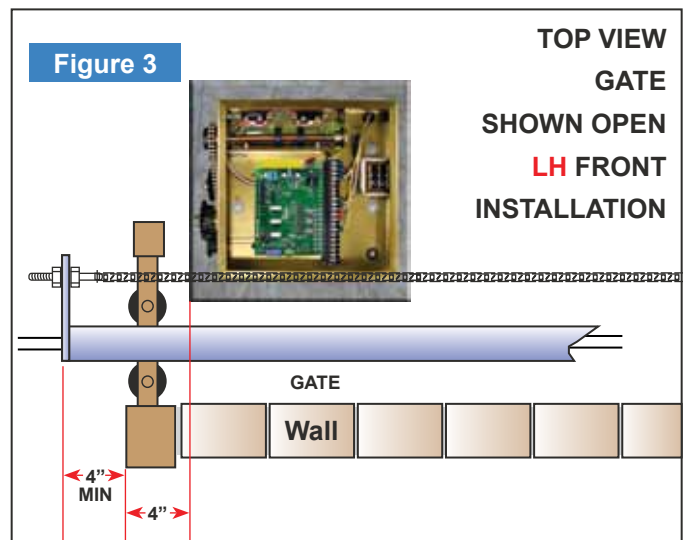
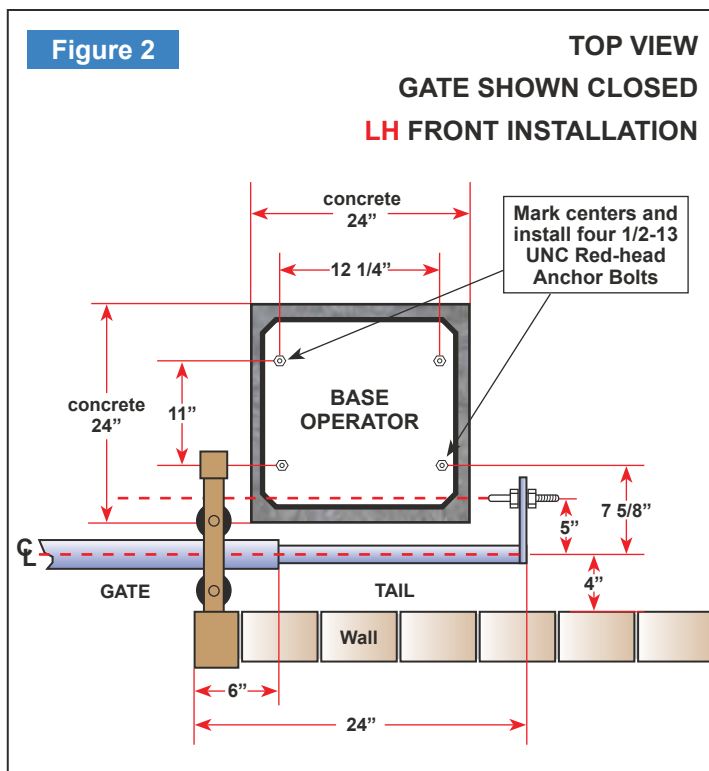
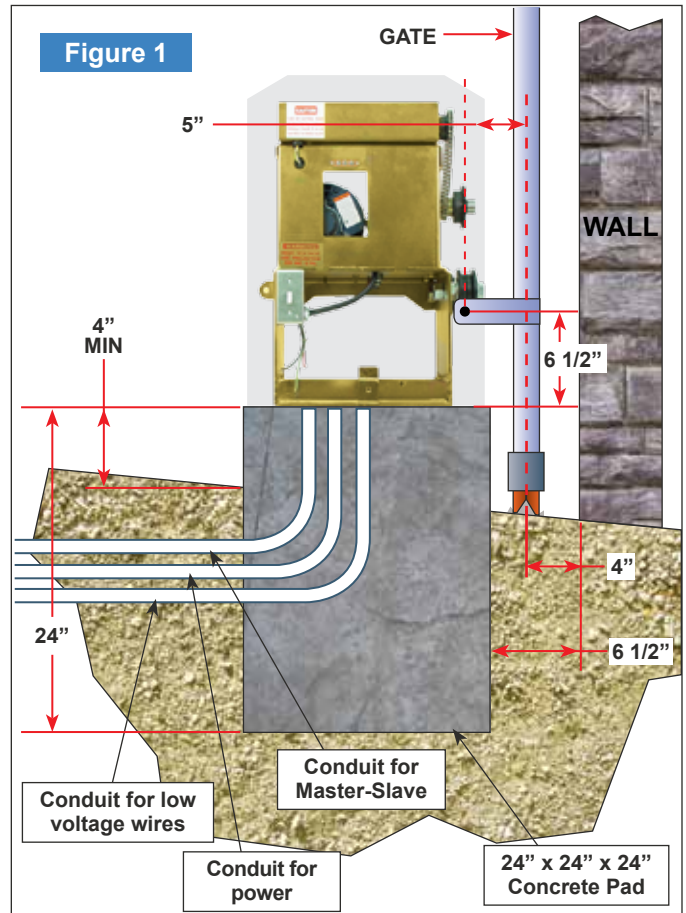



# TYPES OF INSTALLATIONS

**FRONT INSTALLATION**  
GATE SHOWN **Closed**  
Tail on gate required

Figure 4

Inside Property

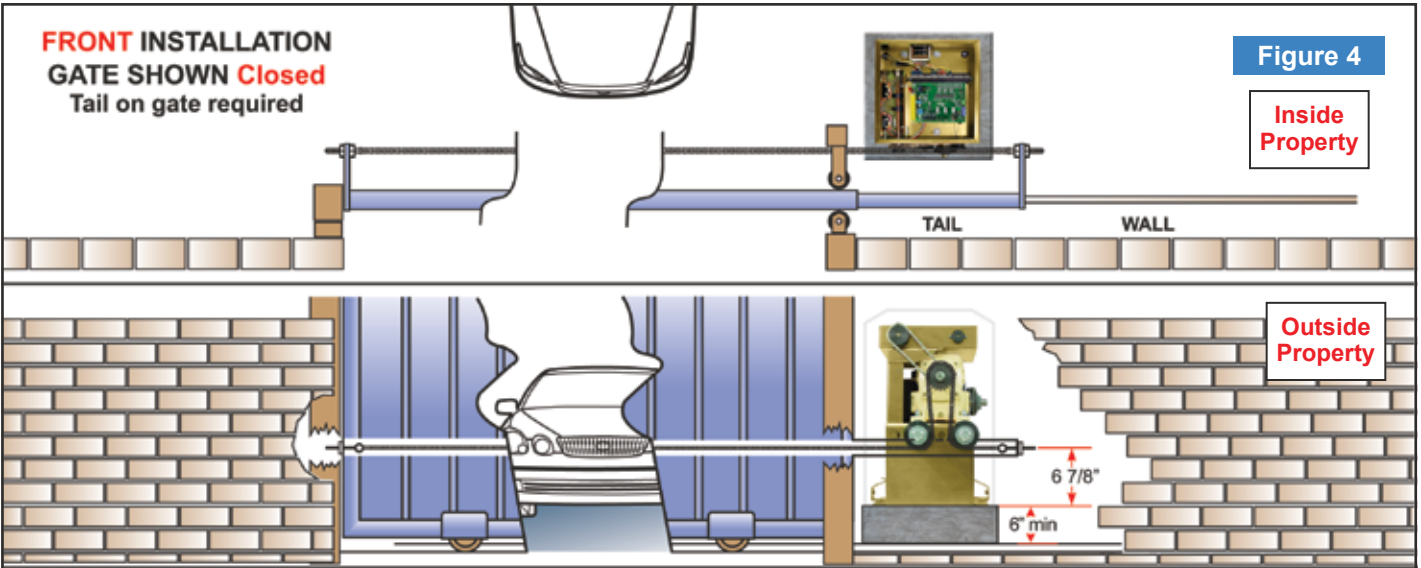

**CENTER INSTALLATION**  
GATE SHOWN **Fully Open**  
No tail on gate required

Figure 5

Inside Property

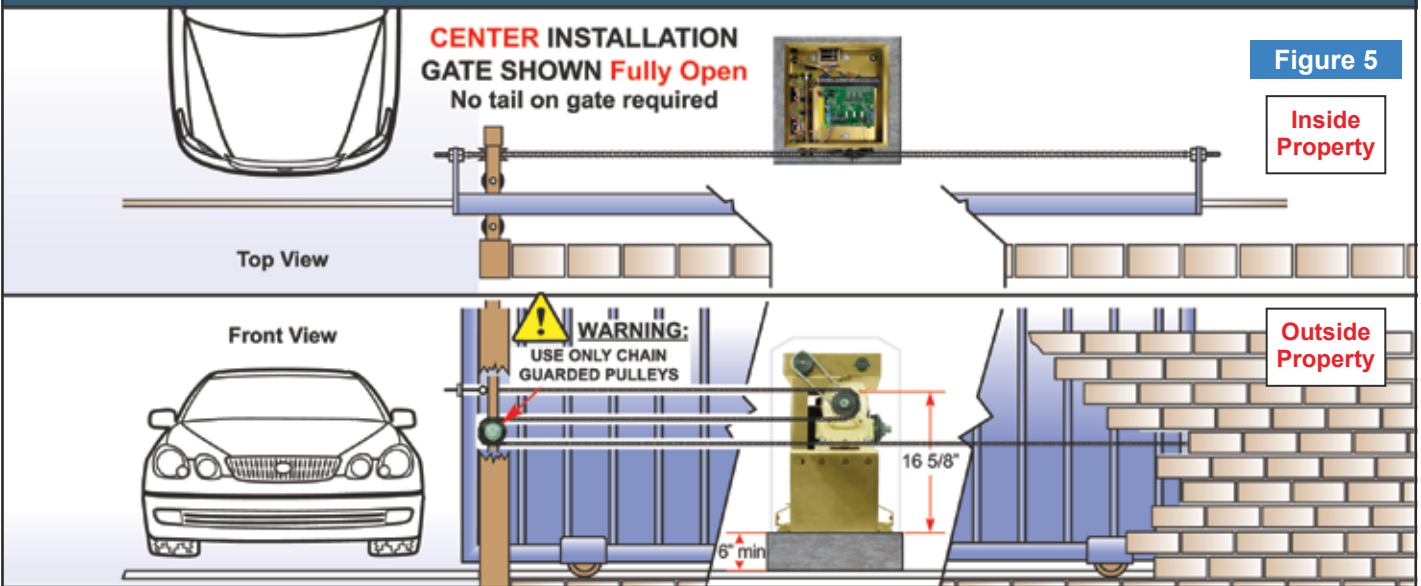

**REAR INSTALLATION GATE SHOWN**  
**Fully Open**  
No tail on gate required

Figure 6

Inside Property

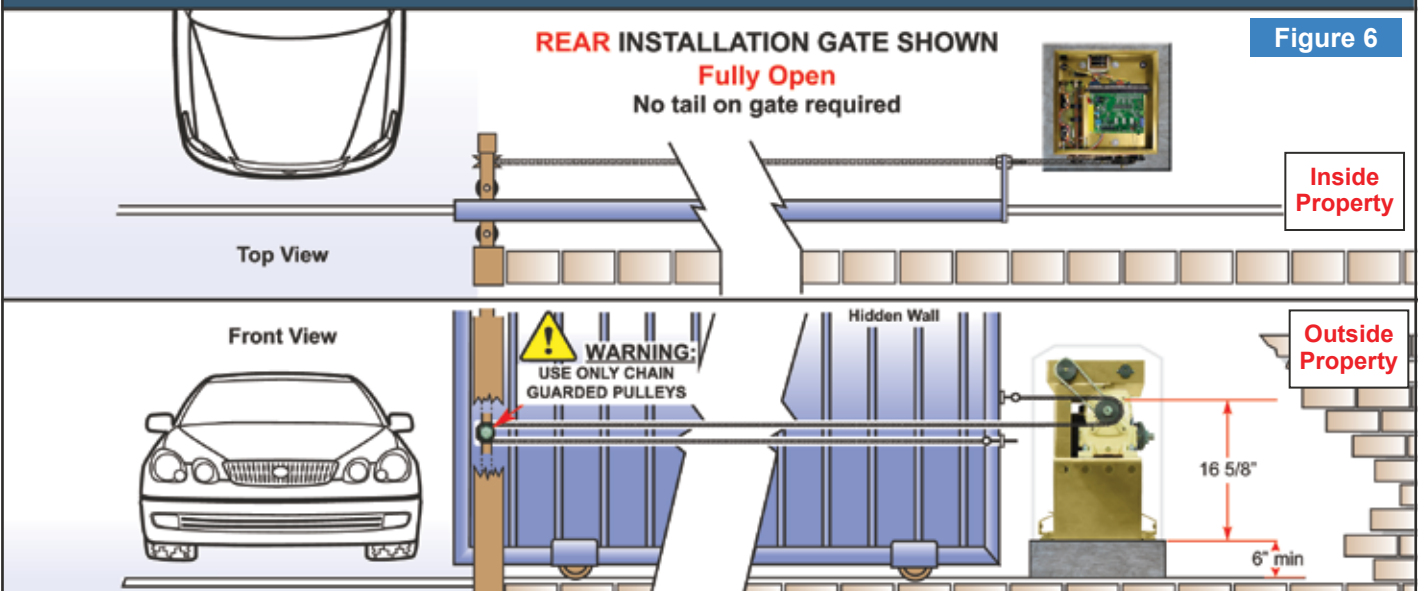

## LOOP SENSOR INSTALLATION

Ramset Gate Operators should always be installed with non-contact sensing devices such as Loop Detectors, Photo Eyes or the equivalent.



### WARNING

A non-contact sensor (photoelectric sensor or equivalent) and a contact sensor (edge device or equivalent) is required on each individual installation to comply with UL325.

**Reversing Loops** on the ground floor, prevents gate from closing when vehicle is in loop area.

**Exit Loops** on the ground floor, opens gate when vehicle crosses loop area.

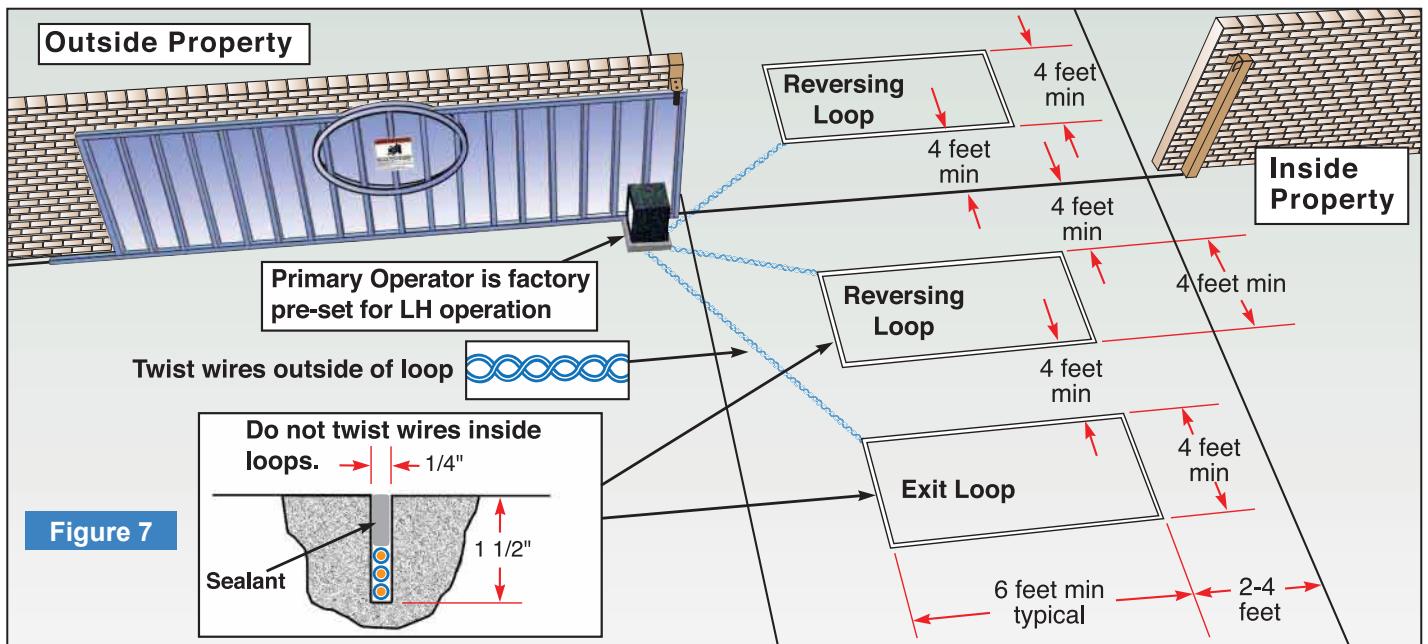

## GATE TRAVEL ADJUSTMENT



### WARNING: TURN POWER OFF BEFORE ATTEMPTING ADJUSTMENT

To adjust gate travel, depress spring loaded bracket and spin each Adjustment Nut to the required position (Figure 8). L.E.D. must turn on to indicate position open or close when limit switch is activated by limit switch adjustment nut.

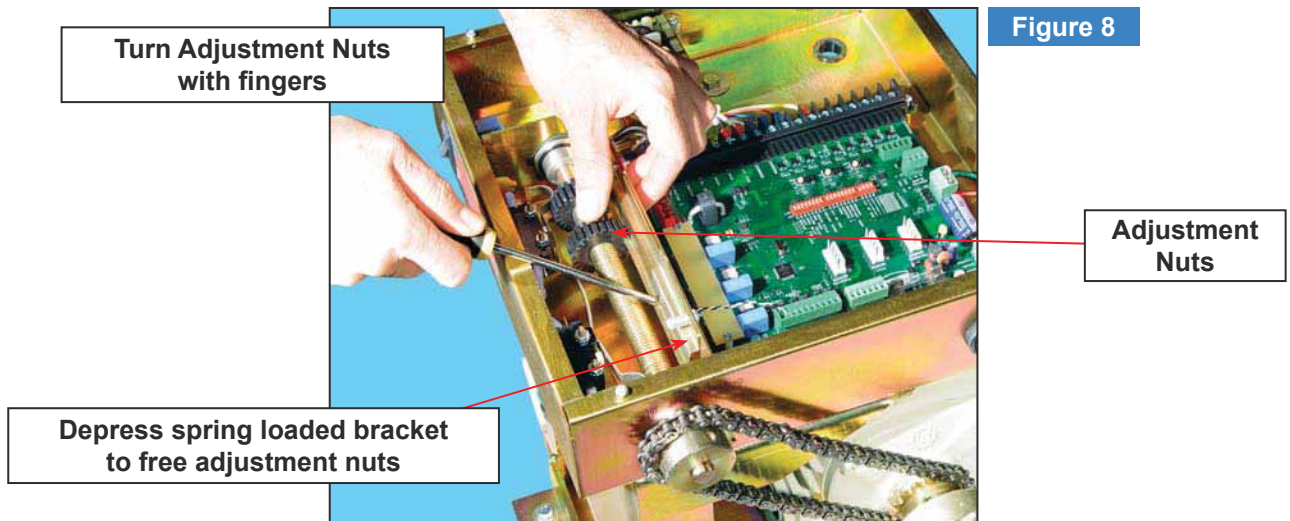

## PUSHBUTTON CONTROLS

Three pushbuttons are located under the dip switches for operation of the gate (see Figure 9). The **opening**, **stop** and **closing** buttons can be utilized to set limit switches and verify proper system operation when installing or servicing an operator.

**Opening**

Pressing this button will cause the gate to open.

**Stop**

Pressing this button will cause the gate to stop moving.

**Closing**

Pressing this button will cause the gate to close.

**Reset E.R.D. Board**

Push all three pushbuttons for approximately 5 seconds. All three L.E.D.'s should blink.

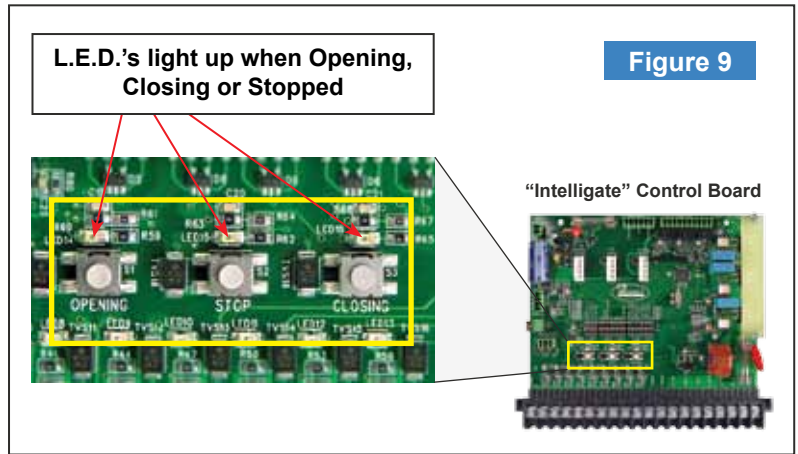

**Figure 9**

## MASTER / SLAVE INSTALLATION

Set Dip Switch (C8) "Slave Mode" to ON for slave operation.  
 (RH) Right Hand operation requires Dip Switch (C7) "Left/Right" to be ON.



**Figure 10**

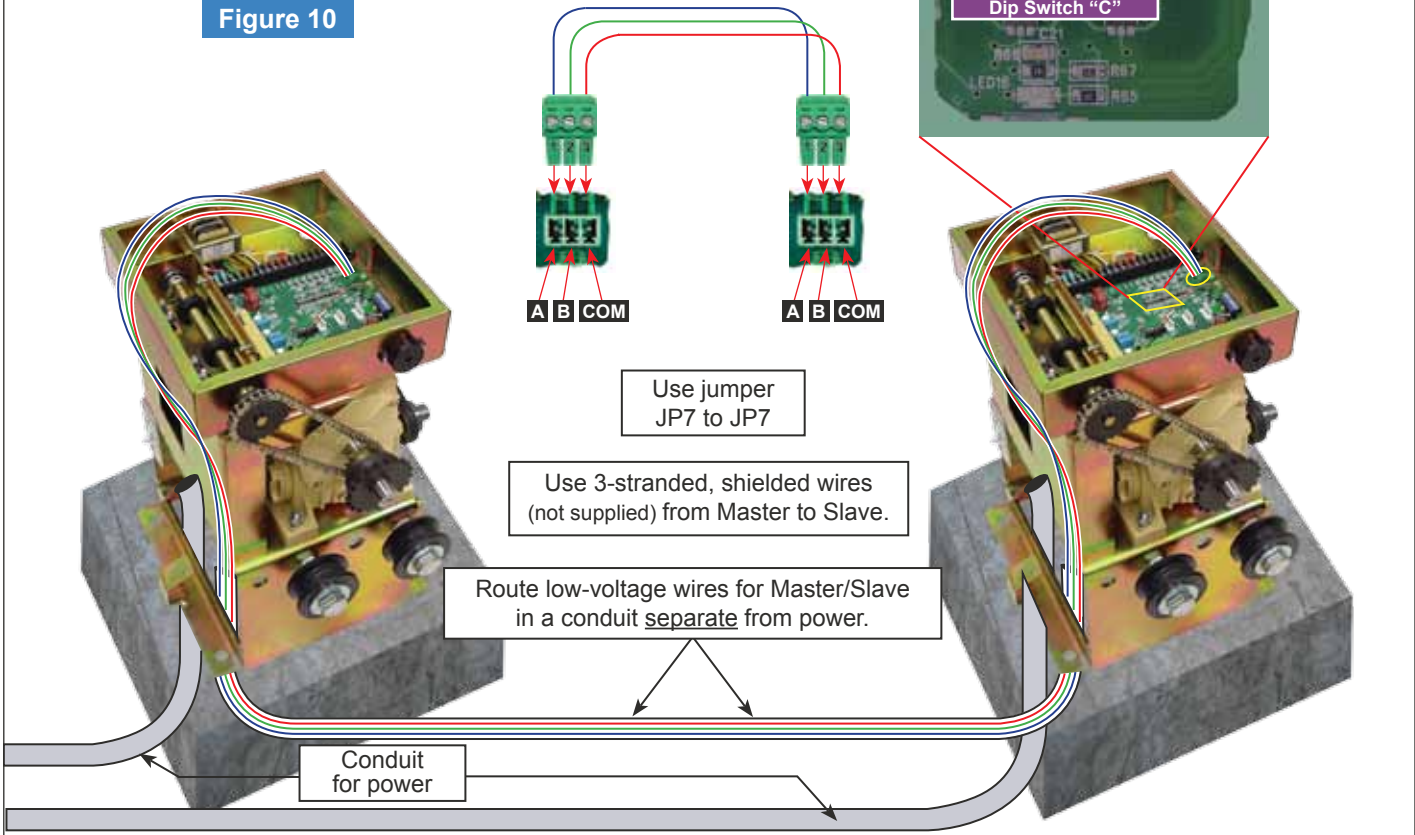

RAM 5000 • 5100 • 5200



# DIP SWITCH CONFIGURATION

Figure 11

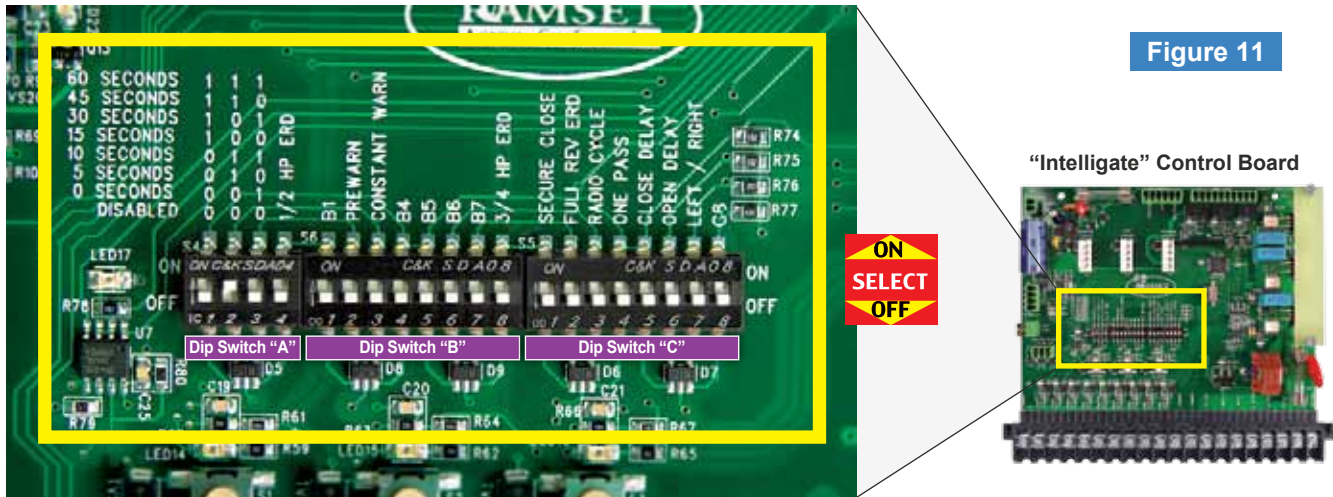

RAM 5000 • 5100 • 5200

## DIP SWITCH "A"

### Dip Switch "A" 1, 2 & 3; AUTOMATIC TIMER TO CLOSE GATE

'0' is "OFF"	'1' is "ON"			
Switch	1	2	3	Gate Open Duration:
	1	1	1	60 seconds
	1	1	0	45 seconds
	1	0	1	30 seconds
	1	0	0	15 seconds
	0	1	1	10 seconds
	0	1	0	05 seconds
	0	0	1	00 seconds
	0	0	0	Disabled - command required to close

### Dip Switch "A" 4 - 1/2 HP ERD

Dip switch A4 works with Dip switch B8

DIP	A4	B8	Sensitivity
	OFF	OFF	Most Sensitive
	ON	OFF	1/2 Hp — Medium Sensitivity
	OFF	ON	3/4 Hp — Medium Sensitivity
	ON	ON	Least Sensitive

## DIP SWITCH "B"

### Dip Switch "B" 1; Not in use at this time.

Leave in the 'Off' position.
------------------------------

### Dip Switch "B" 2; "PRE WARN"

Used with JP2 "Relay Connections": pins 7 & 8. Triggers a relay, for an alarm or light (not included), for 3 seconds before the gate will move in any direction.

Sw.	Function:
ON	Triggers the relay on JP2 pins 7 & 8 for 3 seconds.
OFF	Regular working conditions

### Dip Switch "B" 3; "CONSTANT WARN"

Used with JP2 "Relay Connections": pins 7 & 8. Triggers a relay, for an alarm or light (not included), to be active anytime the gate is in motion.

Sw.	Function:
ON	Triggers the relay on JP2 pins 7 & 8 while the gate is moving
OFF	Regular working conditions

### Dip Switch "B" 4,5,6 & 7; Not in use at this time.

Leave in the 'Off' position.
------------------------------

### Dip Switch "B" 8 - 3/4 HP ERD

Dip switch B8 works with Dip switch A4

DIP	A4	B8	Sensitivity
	OFF	OFF	Most Sensitive
	ON	OFF	1/2 Hp — Medium Sensitivity
	OFF	ON	3/4 Hp — Medium Sensitivity
	ON	ON	Least Sensitive

# DIP SWITCH CONFIGURATION

## DIP SWITCH "C"

Dip Switch "C" 1; "SECURE CLOSE"	
Sw.	Function:
OFF	Normal Operation
ON	When power is lost, then regained, control board checks status of the gate. If open and safety devices are cleared, gate will close automatically.

**WARNING:**  
 When installing or servicing an operator, make sure switch "C" 1 is 'Off'. If switch "C" 1 is 'On', the gate will move when power is applied and severe injury may occur.

Dip Switch "C" 2; "FULL REV ERD"	
Changes how long a gate will reverse when an obstruction is met when closing.	
Sw.	Function:
ON	Reverses until the open limit is reached
OFF	Reverses for 2 seconds and stops again.

Dip Switch "C" 3; "RADIO CYCLE"	
Sw.	Function:
OFF	Normal Operation - gate only opens and closes on the limit switches. If the gate is in travel then it will always open.
ON	Cycle mode - gate opens and closes on the limit switches, but if in travel, then it will stop with a first command and reverse with a second command.

Dip Switch "C" 4; "ONE PASS"	
Sw.	Function:
OFF	Normal Operation - fully opens and closes
ON	One pass mode - The gate will open until "the reversing loop" is initially activated and then cleared, the gate will then close. If the "reversing loop" is then activated again, before the gate is fully closed, the gate will stop until the "reversing loop" is cleared, then continue to close.

Dip Switch "C" 5; "CLOSE DELAY"	
	One second delay on the closing of the gate.

Dip Switch "C" 6; "OPEN DELAY"	
	One second delay on the opening of the gate.

Dip Switch "C" 7; "LEFT / RIGHT"	
Sw.	Function:
OFF	Left hand installations - All operators come factory
ON	Right hand installations - Reverses motor & limit switches without moving any wires.

Dip Switch "B" 8; Not in use at this time.	
	Leave in the 'Off' position.

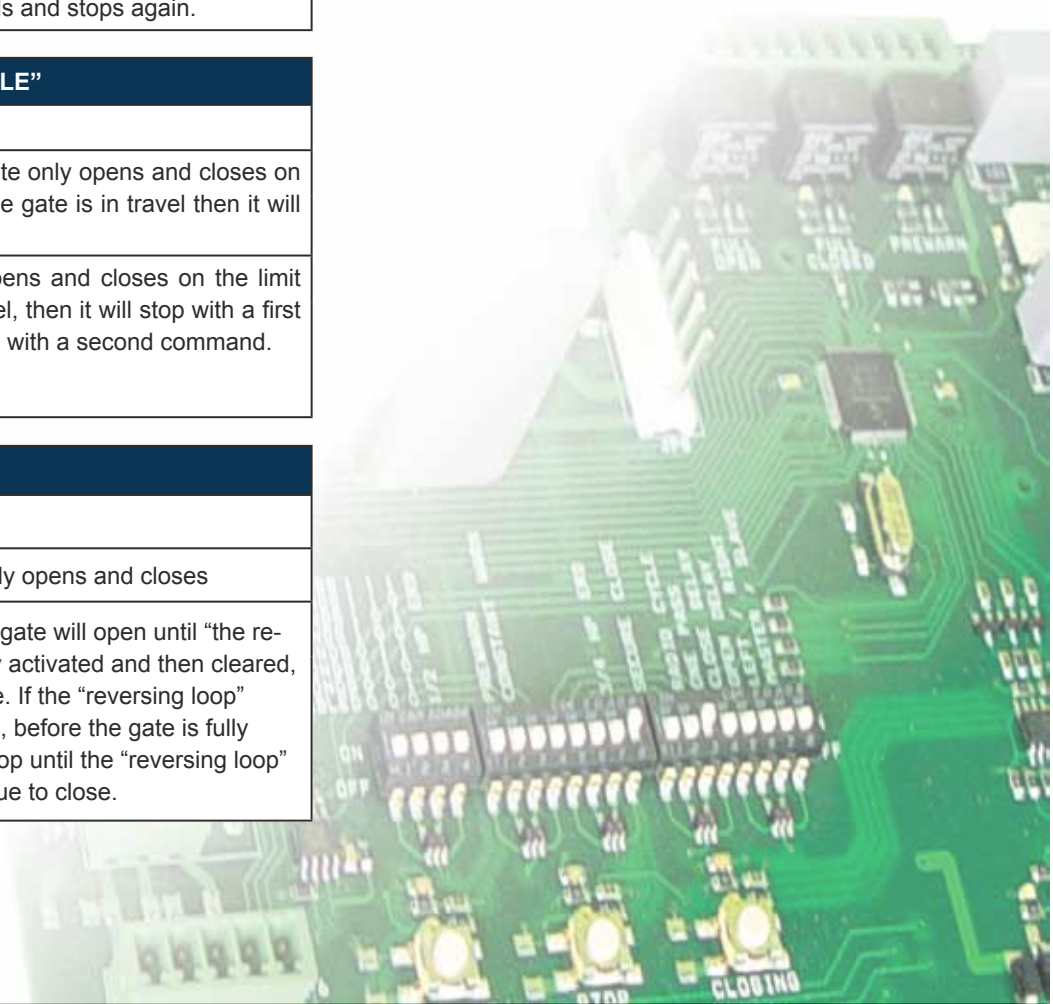

RAM 5000 • 5100 • 5200



# TERMINAL STRIP CONNECTIONS

Figure 12

RAM 5000 • 5100 • 5200

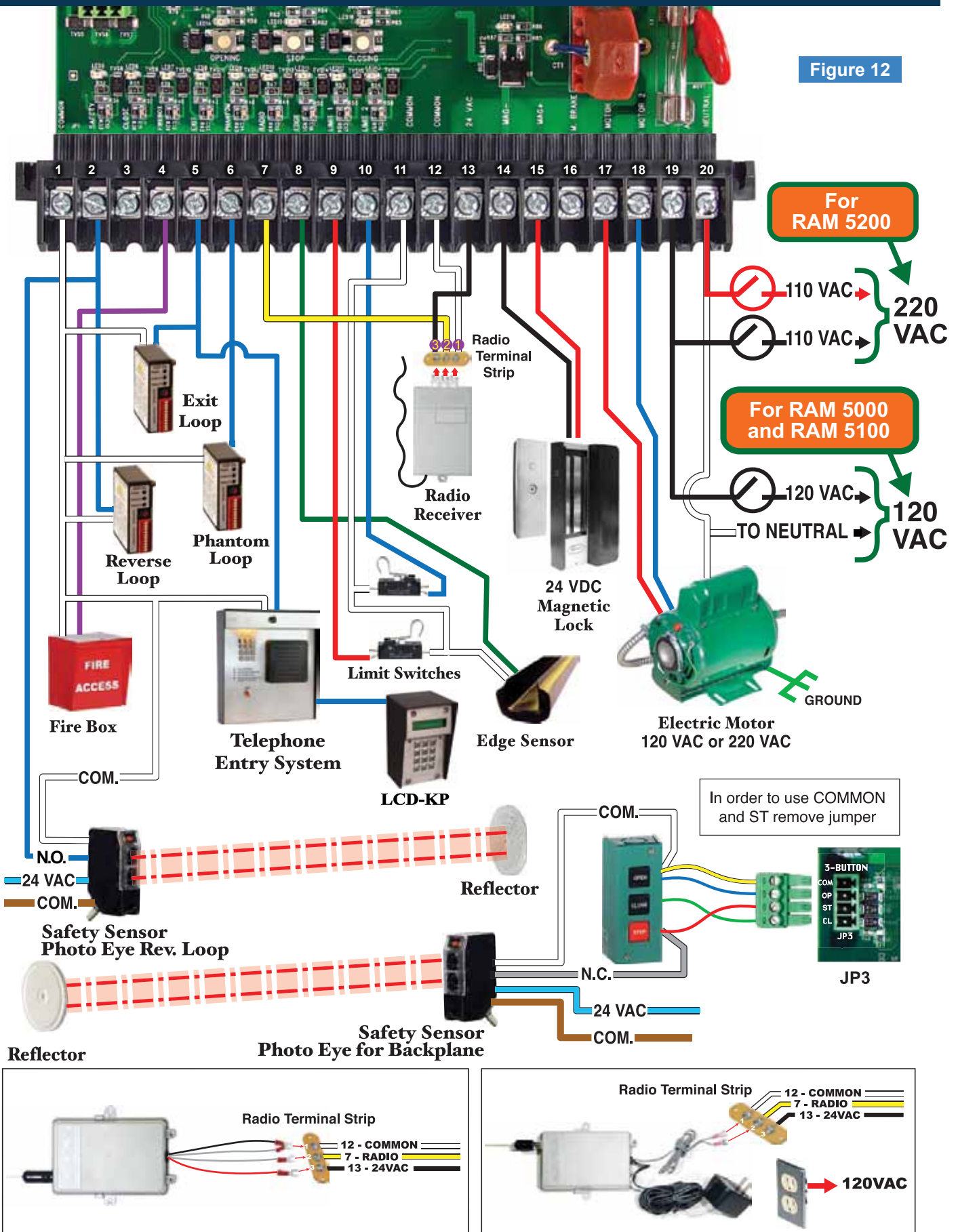

## TERMINAL STRIP CONNECTIONS

### Terminal # 1 - COMMON:

Low voltage common.

### Terminal # 2 - REV LOOP:

Stops the gate from closing. If the gate is open, it holds the gate open. If the gate is closing, it stops and reopens the gate. If the gate is closed, the gate will remain closed. The function can be altered with Dip Switch "C" 4 (see "Dip Switch Configuration"). Used with loop detectors, photo eyes, safety edges...etc. Becomes active with a closed contact to common.

### Terminal # 3 - CLOSE:

Closes the gate. Used with three button stations or pushbuttons. Becomes active with a closed contact to common.

### Terminal # 4 - FIREBOX:

Opens the gate. Used with fire department key switches & controls. Opens with closed contact to common. Closes immediately when closed contact on common is removed.

### Terminal # 5 - EXIT:

Opens the gate. Used with loop detectors, photo eyes, keypads, phone entry systems, three-button stations...etc. Becomes active with a closed contact to common.

### Terminal # 6 - PHANTOM:

Keeps the gate open when the open limit switch is activated. Used with loop detectors. Becomes active with a closed contact to common.

### Terminal # 7 - RADIO:

Operation depends on dip switch "C" 3 (See "Dip Switch Configuration"). Used with an RF receiver or pushbutton. Becomes active with a closed contact to common.

### Terminal # 8 - EDGE:

When triggered the gate will stop. The gate will remain stopped until the detector is cleared. Once the detector is cleared, the operator will resume

normal operation. If triggered twice before reaching a limit switch, the alarm will sound for 6 minutes and the control board will not accept any commands. After the 6 minutes the 24 VDC is removed from the alarm connection and the board resets to normal operation.

### Terminal # 9 and 10 - LIMIT 1 & LIMIT 2:

Direction depends on Dip Switch "C" 7 (See "Dip Switch Configuration"). Stops the motor from moving in one direction. These wires are preset in factory and should not be moved. Becomes active with a closed contact to common.

### Terminal # 11 and 12 - COMMON:

Low voltage common.

### Terminal # 13 - +24 VAC:

Provides 24 VAC for peripheral accessories.

### Terminal # 14 and 15 - MAG (-) & MAG (+):

Supplies 24 VDC to a Magnetic Lock when the gate is closing or closed. If gate is opening or opened, then no power is supplied. Leave open if not used.

### Terminal # 16 - M BRAKE:

Used ONLY on the Ram 50 Operator. If while the gate is closed someone or something tries to manually open the gate without a proper signal (keypad, exit loop, radio signal...), the motor will lock up for 6 minutes. After the 6 minutes, the operator will then secure close the gate.

### Terminal # 17 and 18 - MOTOR 1 & MOTOR 2:

Supplies power to the motor. Direction depends on Dip Switch "C" 7 (see "Dip Switch Configuration"). These wires are preset and connected in the factory and should not be moved.

### Terminal # 19 and 20 - AC HOT & NEUTRAL:

110 VAC or 220 VAC to power the operator. Voltage is predetermined at factory and cannot be changed by the installer or technician.

# RAMSET "INTELLIGATE" CONTROL BOARD

## Introduction:

Ramset's "Intelligate" Control Board works with Sliding, Swinging and Overhead vehicular gate operators. It is controlled by a programmable microprocessor that reads and precisely executes all functions of the Control Board. The Control Board is powered by a separate mounted 24 VAC transformer. This allows no necessary board modifications between 110

VAC and 220 VAC single-phase applications. Some of the functions of the Control Board are: 0 - 60 seconds automatic close timer, self adjusting E.R.D. with low and high setting, constant warning, prewarning, secure close, one pass, open & close delay, left/right hand operation, plug-in loop detectors and RS485 three wire master/slave connection.

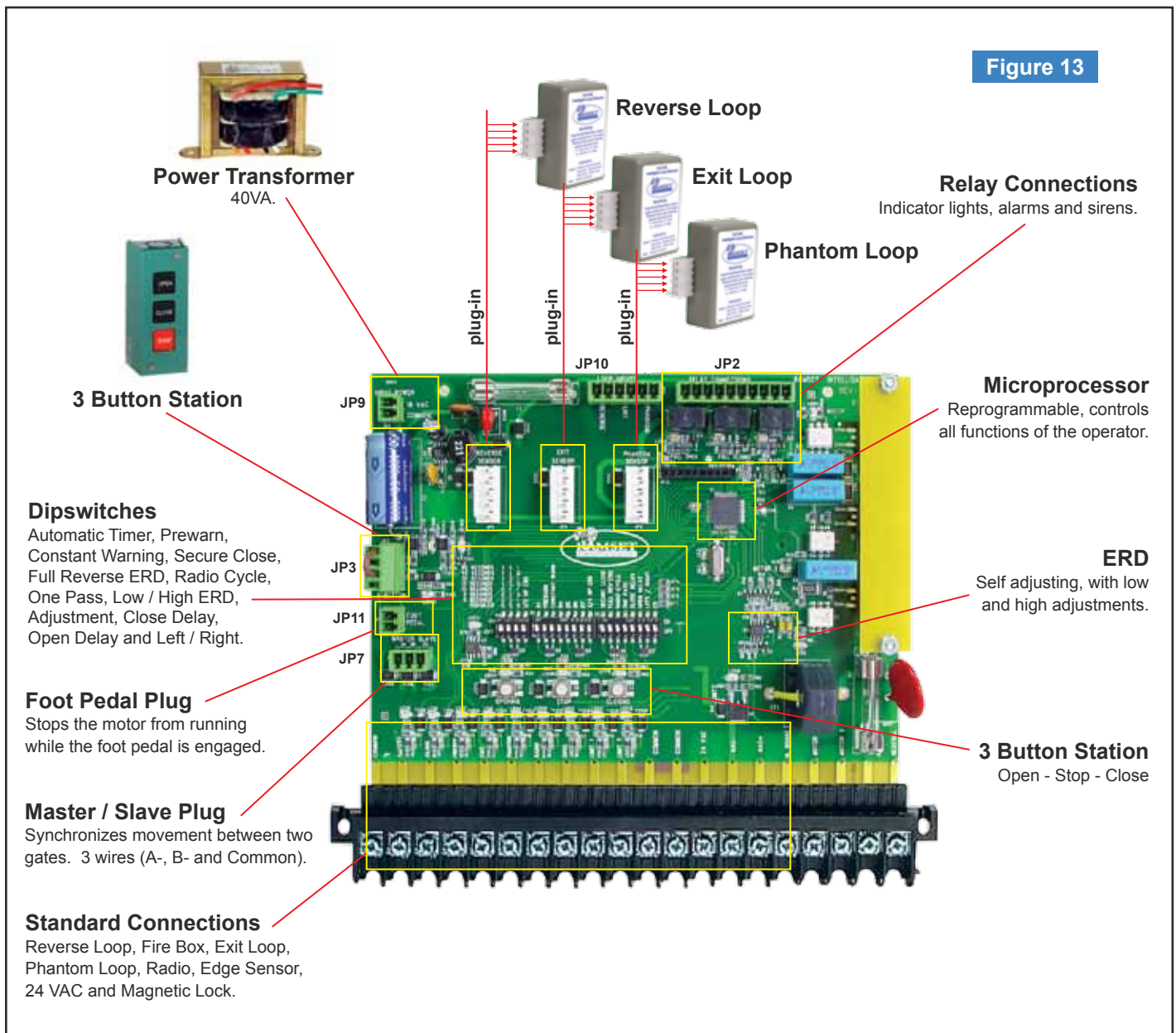

RAM 5000 • 5100 • 5200



## WIRE BOARD CONNECTIONS



### JP9 - Input Power:

1,2) 24 VAC power.

Connection from external transformer to power Control Board.



### JP3 - 3 Button:

1) Open 2) Stop 3) Close 4) Common

Used with a 3-button station to open, stop, and close the gate. The open and close are normally open connections and the stop is a normally closed connection, remove jumper wire when connecting 3 button station. Common and stop are also used with a photo eye used to protect the backplane of the operators.



### JP11 - Foot Pedal Plug:

Stops the motor from running while the foot pedal is engaged.



### JP7 - Master/Slave plug:

1) A 2) B 3) Common

Used to synchronize the operation between two gates. A three-wire, Shielded cable is needed to run from the A, B, & Common (JP7) of the master P.C.B. to the A, B, & Common (JP7) of the slave P.C.B.



### JP10 - Loop Inputs:

1-2) Reverse 3-4) Exit 5-6) Phantom

Use with ILD-24s, Loop wires should be connected to this plug.

### JP4, JP5 & JP8 - Reverse, Exit & Phantom Sensor:

Used with the Ramset ILD-24 plug-in loop detector. The Loop wires should be connected into the "LOOP INPUTS" plug.



### JP2 - Relay Connections:

1) 24 VDC.

2) 24 VAC

3) 5 VDC

4) Fully Open-N.O.

5) Relay Common

6) Fully Closed-N.C.

7-8) Constant/Prewarn

9-10) E.R.D. Alarm.

If E.R.D. is triggered twice before reaching a limit, 24 VDC is supplied to sound an alarm (included with operator).

### Fully Open N.O. (works with relay common)-

Relay rated at 125 VAC, 2 amps. Normally open connection. Open contact occurs until the open limit is triggered. When the open limit is triggered, a closed contact occurs.

### Relay Common - Relay rated at 125 VAC, 2 amps.

The common of the Fully Closed N.C. relay and the Fully Open N.O. relay.

### Fully Closed N.C. (works with relay common)

Relay rated at 125 VAC, 2 amps. Normally closed connection. Closed contact occurs until the closed limit is triggered. When the closed limit is triggered, an open contact occurs.







## BILL OF MATERIALS

ITEM	PART #	PART DESCRIPTION	RAM 5000	RAM 5100	RAM 5200
1	800-00-07	Chassis	1	1	1
2	800-02-05	Gear Reducer - Size 60, Ratio 30:1	1	1	1
3	800-04-10	Motor, Standard - 120VAC 1/2 HP	1		
4	800-04-12	Motor, Standard - 120VAC 3/4 HP		1	
5	800-04-13	Motor, Standard - 220VAC 1HP			1
6	800-06-01	Sprocket - 35B17 x 1" (2 1/4" OD)	1	1	1
7	800-06-02	Sprocket - 35B17 x 1/2" (2 1/4" OD)	1	1	1
8	800-06-05	Sprocket - 40B21 x 1"	1	1	1
9	800-08-30	Pulley, Steel - 3/4" x 2 1/2"	1	1	1
10	800-08-40	Pulley, Steel - 5/8" x 2 1/2" (AK25)	1	1	1
11	800-10-13	Belt - 4L-210	1	1	1
12	800-14-08	Cover, Polyethylene	1	1	1
13	800-20-04	Limit Switch	2	2	2
14	800-22-04	Spring - 1/4" x 1/2"	2	2	2
15	800-52-00	Chain - #40 (10ft per box)	2	2	2
16	800-52-20	Chain, Limit - #35 x 23 1/8" (31 Links)	1	1	1
17	800-52-30	Chain Bolt - 1/2" - 13 x 3 1/4"	2	2	2
18	800-54-15	Bracket, Chain (Left) - 3/8" x 2" x 2" x 3 1/4"	1	1	1
19	800-54-16	Bracket, Chain (Right) - 3/8" x 2" x 2" x 3 1/4"	1	1	1
20	800-54-78	Bracket, Spring Loaded - Ram 5000s - 6 1/2" x 1 1/4"	1	1	1
21	800-56-03	Box, Control Board Metal	1	1	1
22	800-60-00	Transformer, 120/240V to 18VAC - 40VA UL	1	1	1
23	800-60-10	Switch, Rocker	1	1	
24	800-60-11	Switch, Power - 220 VAC			1
25	800-60-12	Switch Cover - Single			1
26	800-60-20	Outlet, 120VAC Dual	1	1	
27	800-60-25	Outlet Cover - 2 plug/switch	1	1	
28	800-62-00	Control Board - Intelligate	1	1	1
29	800-64-00	Edge Connector - 20 Pin	1	1	1
30	800-66-05	Lexan Control Board Cover - Ram 5000s - 12 1/4" x 12 1/2"	1	1	1
31	800-68-08	Instruction Manual	1	1	1
32	800-70-20	Horn Alarm Buzzer	1	1	1
33	800-70-55	Radio Receiver Terminal	1	1	1
34	800-70-99	Warning Sign For Gates - Slide/Swing	2	2	2

## BILL OF MATERIALS

ITEM	PART #	PART DESCRIPTION	RAM 5000	RAM 5100	RAM 5200
35	800-75-32	<b>IDLER WHEEL ASSEMBLY</b>	2	2	2
36	800-36-64	Bolt, Hex Head - 5/8" - 11 x 3 1/2"	2	2	2
37	800-46-01	Bushing, Idler Wheel Sleeve - ID 5/8" : OD 7/8" x 1 11/16"	2	2	2
38	800-70-31	Idler Wheel, UHMW - 3 1/2" x 1 1/2" - I.D. 7/8"	2	2	2
39	800-75-72	<b>LIMIT SHAFT ASSEMBLY</b>	1	1	1
40	800-12-05	Shaft, Limit Switch - 1/2" - 2.5 x 10 5/16" (6 5/8" of thread)	1	1	1
41	800-20-50	Limit Switch Nuts	2	2	2
42	800-44-04	Bearing, Sealed - 6202RS x 1/2"	2	2	2
43	800-70-10	Collar, Limit Shaft - 1/2"	2	2	2
44	800-75-60	<b>CHAIN RELEASE ASSEMBLY</b>	1	1	1
45	800-52-35	Chain Bolt Coupler	1	1	1
46	800-52-36	Chain Bolt Release	1	1	1

## GATE ENTRANCE SAFETY PRECAUTIONS



**WARNING** Not following these instructions may cause severe injury or death to persons



RAM 5000 • 5100 • 5200

### ⊘ IMPORTANT SAFETY INSTRUCTIONS

1. Never let children operate or play with gate controls. Keep the controls away from children.
2. The entrance is for vehicles only. Pedestrians should use a separate entrance.
3. Always keep people, children and objects away from the gate while the gate is in operation. No one should cross the area of a moving gate.
4. No opening devices such as a keypad, cardreader etc., should be installed close to the gate, where the gate could possibly cause injury.
5. Use warning signs attached on both sides of the gate.





## IMPORTANT INFORMATION FOR THE HOMEOWNER



- ❖ Ask your technician about all the features of our new Ramset operator.
  - ❖ Safety devices, such as reversing loops, phantom loops, photo eyes, or miller edges must be installed on your gate before the operator may be used. Ask your technician which safety devices best suit your safety needs.
  - ❖ Read your warranty certificate and fill out your warranty extension card. Return the warranty card, via certified mail, to Ramset within 90 days of purchase:
 

**Ramset Automatic Gate Services, Inc.**  
**9116 De Garmo Ave.**  
**Sun Valley, CA. 91352**
  - ❖ Never let children operate or play with gate controls. Keep the controls away from children.
  - ❖ The entrance is for vehicles only. Pedestrians should use a separate entrance.
  - ❖ Always keep people, children and objects away from the gate while the gate is in operation. No one should cross the area of a moving gate.
  - ❖ Use the emergency release only when the gate is not moving & power is turned off to the unit.
  - ❖ Have the technician give you a demonstration of how to use the emergency release.
  - ❖ Keep gates properly maintained. Have a qualified gate technician service the gate operator and gate hardware every six months to a year. This includes checking of safety devices, E.R.D. and battery back up systems.
  - ❖ Warning signs must be placed on every gate in a highly visible area.
  - ❖ To reset the audible alarm on the gate operator you must turn the power of the unit off for approximately 10 seconds, then back on.
  - ❖ Always keep a good relationship with your technician and keep his or her number handy for future maintenance or emergencies.
- Ramset wishes to thank you for trusting us to meet your gate operator needs***

## TROUBLESHOOTING TABLE

CONDITION	POSSIBLE CAUSES	SOLUTION
<b>NO LIGHTS ARE 'ON'.</b>	<ol style="list-style-type: none"> <li>1. Circuit breaker popped.</li> <li>2. 1/2 amp. fuse blown.</li> <li>3. Power supply damaged on Control Board.</li> </ol>	<ol style="list-style-type: none"> <li>1. Reset circuit breaker.</li> <li>2. Replace 1/2 amp. fuse.</li> <li>3. Return Control Board for repair.</li> </ol>
<b>GATE MOVES A COUPLE OF FEET AND THEN REVERSES.</b>	<ol style="list-style-type: none"> <li>1. E.R.D. too sensitive.</li> </ol>	<ol style="list-style-type: none"> <li>1. A) for 1/2 hp motors: turn dip switch "A" 4 'On'. B) for 3/4 hp motors: turn dip switch "B" 8 'On'.</li> </ol>
<b>"EXIT" L.E.D. IS ALWAYS 'ON'.</b>	<ol style="list-style-type: none"> <li>1. Faulty accessory connected to the "Exit".</li> </ol>	<ol style="list-style-type: none"> <li>1. Disconnect all accessories, including plug-ins, using the "Exit" input. If problem persist, contact Ramset.</li> </ol>
<b>"REV LOOP" L.E.D. ALWAYS 'ON'.</b>	<ol style="list-style-type: none"> <li>1. Faulty accessory connected to the "Rev Loop".</li> </ol>	<ol style="list-style-type: none"> <li>1. Disconnect all accessories, including plug-ins, using the "Rev Loop" input. If problem persist, contact Ramset.</li> </ol>
<b>"RADIO" L.E.D. ALWAYS 'ON'.</b>	<ol style="list-style-type: none"> <li>1. Stuck button on Transmitter</li> <li>2. Faulty Receiver.</li> </ol>	<ol style="list-style-type: none"> <li>1. Check all transmitters.</li> <li>2. Remove receiver. If problem persist, contact Ramset.</li> </ol>
<b>GATE DOESN'T OPEN.</b>	<ol style="list-style-type: none"> <li>1. Radio L.E.D. 'On'.</li> <li>2. 10 amp. fuse blown.</li> <li>3. Opening accessory not functioning.</li> </ol>	<ol style="list-style-type: none"> <li>1. See above symptoms/solutions.</li> <li>2. Check/replace 10 amp. fuse.</li> <li>3. Check/replace opening accessory.</li> </ol>
<b>GATE DOESN'T CLOSE.</b>	<ol style="list-style-type: none"> <li>1. No lights are 'On'.</li> <li>2. Exit, Rev Loop, Radio L.E.D. 'On'.</li> <li>3. 10 amp. fuse blown.</li> <li>4. Thermal/overload button popped on motor.</li> </ol>	<ol style="list-style-type: none"> <li>1. See above symptoms/solutions.</li> <li>2. See above symptoms/solutions.</li> <li>3. Check/replace 10 amp. fuse.</li> <li>4. Reset thermal/overload button on the back of the motor.</li> </ol>
<b>GATE DOESN'T CLOSE AUTOMATICALLY.</b>	<ol style="list-style-type: none"> <li>1. Dip switches "A" 1-3 are all 'Off'.</li> <li>2. Dip switch not on all the way.</li> </ol>	<ol style="list-style-type: none"> <li>1. Set dip switches "A" 1-3 for auto close.</li> <li>2. Turn off dip switches "A" 1-3, then turn the appropriate switches back 'On'.</li> </ol>
<b>GATE AUTOMATICALLY OPENS, BUT DOESN'T AUTOMATICALLY CLOSE.</b>	<ol style="list-style-type: none"> <li>1. Motor direction wrong.</li> </ol>	<ol style="list-style-type: none"> <li>1. Turn on dip switch "C" 7 (left/right).</li> </ol>
<b>RADIO/RECEIVER HAS NO RANGE.</b>	<ol style="list-style-type: none"> <li>1. Signal blocked.</li> <li>2. Area not suitable for type of Receiver.</li> </ol>	<ol style="list-style-type: none"> <li>1. Make sure antenna is in proper position &amp; not shorted to chassis.</li> <li>2. May need to change to long range receiver.</li> </ol>





**Tel: (800) 878-7829**  
**[www.ramsetstore.com](http://www.ramsetstore.com)**